



HDK OWNER'S MANUAL



HDK ELECTRIC VEHICLES
California Headquarters: 2620 Palisades Drive, Corona CA 92882 USA
Factory Address: NO. 36 Tang'an North Road, Dongfu Town,
Haicang District, Xiamen, China
Tel: +86-592-6530539
Email: Sales@del-ev.com
Website: www.hdkexpress.com



TURFMAN SERIES



Copyright © HDK ELECTRIC VEHICLES
VERSION: 202105

Copyrighted Material
HDK ELECTRIC VEHICLES reserves
the right to change or improve the manual
according to products and company policy alterations
at any time without notice.

TABLE OF CONTENTS

Read carefully all the safety statements before attempting any procedure.

SAFETY INFORMATION.....	1
Safety Signal Words.....	1
Vehicle Safety Labels.....	2
Battery Safety Information.....	3
Lithium-Ion Battery Recycling.....	4
Vehicle Safety Labels Location.....	5
VEHICLE SERIAL NUMBER LOCATION.....	7
Vehicle Serial Number.....	7
Vehicle Vin Number.....	8
VEHICLE FEATURES.....	9
Vehicle Overview.....	9
Front View.....	9
Rear View.....	10
Dash Board Overview.....	11
OPERATION AND CONTROLS.....	11
Pre-Operation Safety And Performance Inspection.....	12
Accelerator Pedal Operation.....	15
Brake Pedal Operation.....	15
Foot Parking Brake Pedal (Mechanical Brake).....	15
Hand Parking Brake (Hydraulic Brake).....	16
Motor Brake Operation (Optional).....	16
Key Switch Operation.....	17
Forward/Neutral/Reverse Control (D/N/R Knob Switch).....	17
High/Low Speed Model Selecting Switch (Optional).....	18
Usb Drive Port & Use Charger Outlet.....	18
Combination Switch Control.....	19
Front Headlight Control.....	19
Turning Signal Lights Control.....	19
Turning Signal Lights Control.....	19
Horn Control.....	19
Motor Brake Release Switch (Electrical).....	20
Motor Brake Release Screws (Mechanical).....	20
Motor Brake Release Lever (Mechanical).....	20
How To Operate A Cart.....	20
Aluminum Cargo box and Flat Bed.....	20

TABLE OF CONTENTS

Read carefully all the safety statements before attempting any procedure.

BATTERY.....	25
Lithium Battery Overview.....	25
Lead Acid Battery Overview.....	26
Battery Meter.....	27
Battery Maintenance.....	27
BATTERY CHARGER.....	31
Battery Charger Specification.....	31
Charger Led Display.....	32
How To Use Charger.....	33
Charger Maintenance.....	34
TOUCHSCREEN.....	35
Touchscreen Overview And Introduction.....	35
Touchscreen Operation.....	36
SPEEDOMETER.....	41
Speedometer Overview.....	41
Speedometer Operation.....	42
TIRE OPERATION.....	43
LIFT AND LOWER THE VEHICLE.....	44
VEHICLE MAINTENANCE.....	45
Vehicle Scheduled Maintenance Chart.....	46
Chassis Maintenance.....	47
Electrical Components Maintenance.....	49
Vehicle Cleaning And Care.....	51
Vehicle Storage.....	52
Vehicle Transportation And Towing.....	54
VEHICLE GENERAL SPECIFICATIONS.....	55
MAINTENANCE LOG.....	57



SAFETY INFORMATION

Read carefully all the safety statements before attempting any procedure.





SAFETY SIGNAL WORDS

Signal words (**DANGER, WARNING, CAUTION, and NOTICE**) and safety messages are in this manual and on safety decals. Read, understand, and obey all instructions, safety precautions, and safety decals before vehicle operations. Safety messages are necessary and must be obeyed.

Replace missing, damaged, or unreadable safety decals immediately to prevent possible property damage, personal injury, or death. Purchase replacement safety decals from your dealer or distributor.

Know and understand all laws and regulations for vehicle operation in your area.







Speak with your dealer or distributor if you have questions about material contained in this manual or the vehicle.

Safety Signal Word	Safety Signal Word
	The safety alert symbol is used to alert you to possible personal injury hazards. Obey all safety messages that follow this symbol to prevent possible injury or death.
	A DANGER identifies a hazardous situation which will result in death or serious injury.
	A WARNING identifies a hazardous situation which could result in death or serious injury.
	A CAUTION identifies a hazardous situation which could result in minor or moderate injury.
	A NOTICE identifies a hazardous situation which could result in property damage.

SAFETY INFORMATION

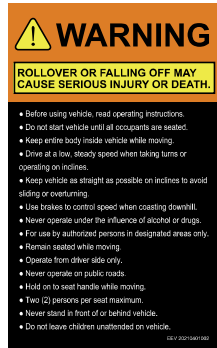
Read carefully all the safety statements before attempting any procedure.

VEHICLE SAFETY LABELS

	
Operation Instruction Decal	
	
Battery Warning Decal	Windshield Warning Decal
	
	Rear Seat Kit Warning Decal
	
Dash Warning Decal	Rear Seat Warning Decal

SAFETY INFORMATION

Read carefully all the safety statements before attempting any procedure.

BATTERY SAFETY INFORMATION

Safety and warning labels are on the lithium battery for your protection. Read and comply with the instructions on the labels carefully for avoiding the potential risks or injury. If any label shown below is damaged or comes off or becomes illegible, contact your HDK dealers for a replacements, printed on the labels, or can be obtained from your dealer.

WARNING FAILURE TO FOLLOW THESE INSTRUCTIONS MAY RESULT IN SEVERE PERSONAL INJURY.

- Service, removal or installation of battery pack must be performed by authorized personnel only.
- Improper handling of batteries and electrical components can result in severe personal injury.
- Do not immerse or throw the battery pack in water. Do not pressure wash the battery pack.
- Do not operate at temperatures below -4°F (-20°C)
- Do not expose to temperatures above 140°F (60°C)

Battery Warning Decal

	While working on a li-ion battery wear protective eyeglasses and clothing
	Explosion and fire hazard. The terminals of a li-ion battery are always live, therefore do not place metallic items or tools on top of a li-ion battery. Avoid short circuits.
	Explosion and fire hazard. The terminals of a li-ion battery are always live, therefore do not place metallic items or tools on top of a li-ion battery. Avoid short circuits.
	Batteries must not be mixed with domestic or industrial waste .
	Do not open or dismantle the battery. Electrolyte is very corrosive. If the battery casing is damaged do not touch the exposed electrolyte or powder because it is corrosive.
	Do not touch any electrical components without any insulation protection.
	Batteries marked with the recycling symbol must be processed via a recognized recycling agency.
	Observe these instructions and keep them located near the battery for future. Read, understand and comply with all warning and instructions.

SAFETY INFORMATION

Read carefully all the safety statements before attempting any procedure.

LITHIUM-ION BATTERY DISPOSAL



- Lithium -ion batteries are recyclable.
- Lithium-ion batteries must be collected and recycled separately from other waste.
- Do not discard lithium-ion batteries as municipal waste.
- Speak with your dealer or distributor on returning or recycling used or damaged battery packs.
- Contact local or state environmental department for disposal information.

WARNING

Failure to operate the vehicles as instructed can cause collision, loss of control or roll over, resulting in severe injury or death. Follow all safety warnings or labels in this owner manual. All operator must read, understand and comply with these warnings and labels before operating the vehicles. Follow the safety information and operating procedures described.

- Operate your vehicle responsibly to prevent dangerous conditions for the operator, passengers and other people in the area of operation
- Operate your vehicle responsibly and keep the vehicle in safe condition of operation
- The driver must keep both hands on the steering wheel and both feet on the floor or pedals.
- Inspect the vehicle before each use to make sure it is in safe operating condition. Perform the daily inspection described in this manual.
- Always have the vehicle checked by an authorized dealer if it is involved in an accident.
- Remove the key when the vehicle is not in use to prevent accidental starting or unauthorized use.
- Drive the vehicle at appropriate speeds for the terrain and conditions. Be aware of environmental conditions that change the terrain and your ability to control the vehicle.
- Do not drive on excessively steep hills. Evaluate the terrain before descending a hill. Drive slowly and deliberately. Use the brake to limit speed and maintain control. Sudden braking or turning can cause loss of vehicle control. Drive straight up or down the hill; do not drive across the hill.
- Operate only in approved areas. Follow all applicable safety rules for the area.

VEHICLE SERIAL NUMBER LOCATION

Read carefully all the safety statements before attempting any procedure.

VEHICLE SERIAL NUMBER

All have vehicle's serial number on the left side of the chassis frame. The front four numbers are the manufacturing year of the vehicle, the other five numbers are the vehicle's serial number given by HDK Electric Vehicles. All the vehicles are documented. After the vehicles are sold out of the factory, HDK corporation will track the vehicles by using the vehicle's serial number as identity. Serial numbers are insurance warranty of HDK corporation. Customers should be aware of the importance of the vehicle's serial numbers.

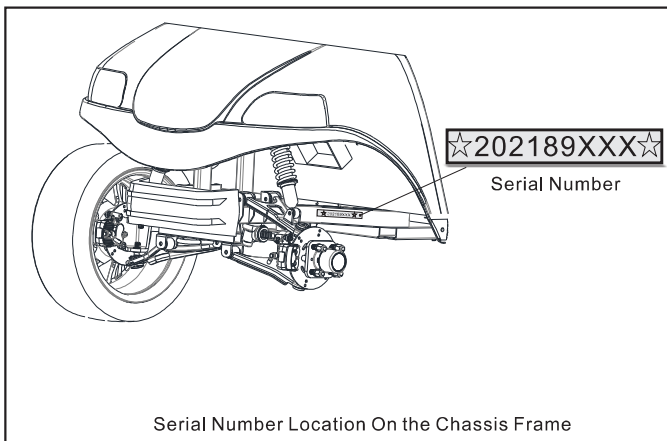

⚠ CAUTION

Design changes occur on a continuous basis. In order to get the correct components for Vehicles, the correct serial number and vehicle model must be supplied. The warranty might be avoided due to serial number is missing. Please contact the dealer and provide the adequate purchase documents for warranty and get a new serial number plate as soon as possible.

VEHICLE SERIAL NUMBER LOCATION

Read carefully all the safety statements before attempting any procedure.

VEHICLE VIN NUMBER (Only for street legal cart)

The VIN number, known as Vehicle Identification Number, includes 17 digital alpha-numeric numbers. VIN number is only used for LSV cart (Low speed vehicle). VIN number plate is located on the driver side of the chassis frame, behind the driver side of front wheel, normally under the serial number plate.

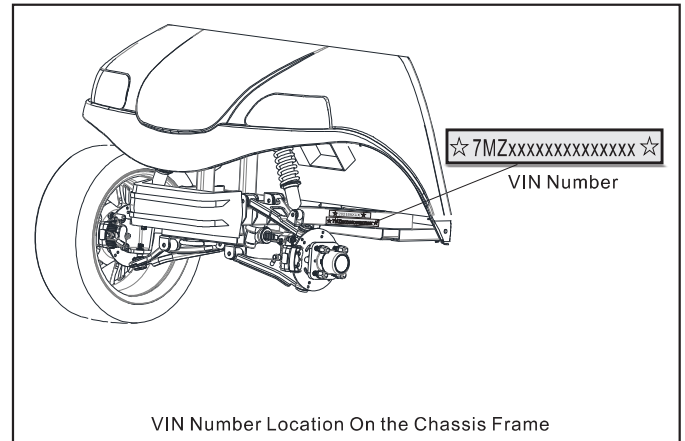

⚠ CAUTION

Design changes occur on a continuous basis. To get the correct components for Vehicles, the correct VIN number or vehicle model must be supplied. The warranty might be avoided due to VIN number is missing. Please contact the dealer and provide the adequate purchase documents for warranty and get a new VIN number plate as soon as possible.



VEHICLE FEATURES

Read carefully all the safety statements before attempting any procedure.

VEHICLE OVERVIEW

Front view

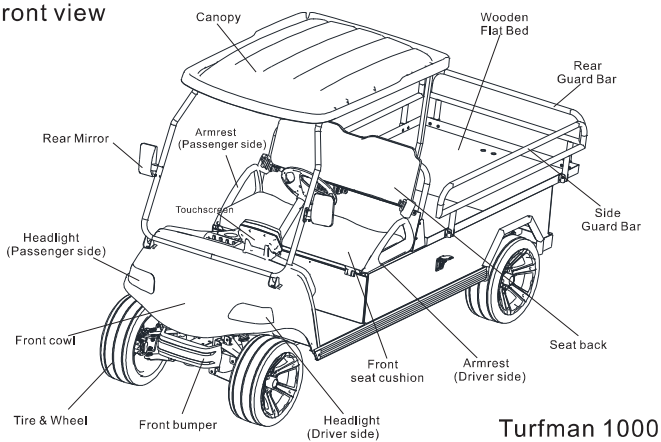

Turfman 1000

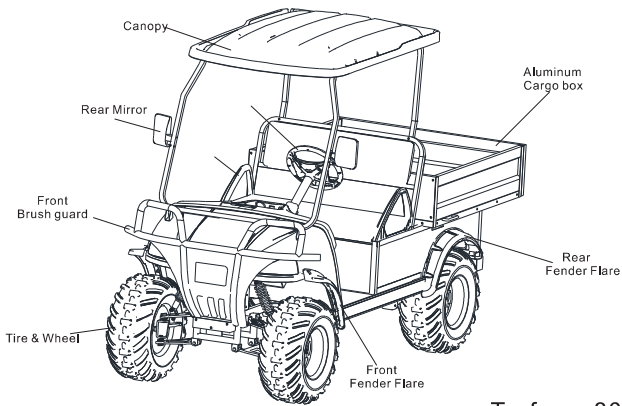

Turfman 800

VEHICLE FEATURES

Read carefully all the safety statements before attempting any procedure.

VEHICLE OVERVIEW

Rear view

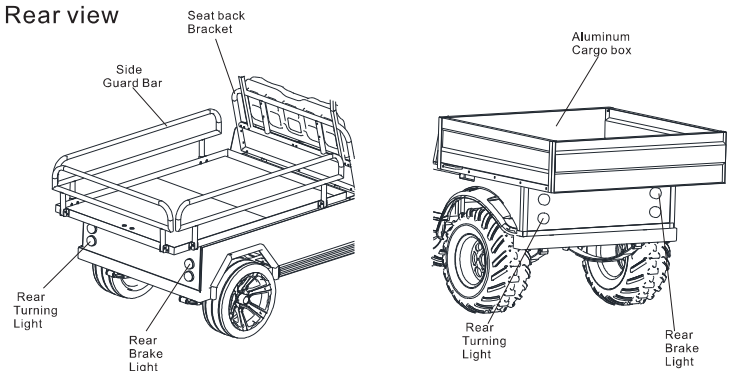

Turfman 1000

Turfman 800

DASH BOARD OVERVIEW

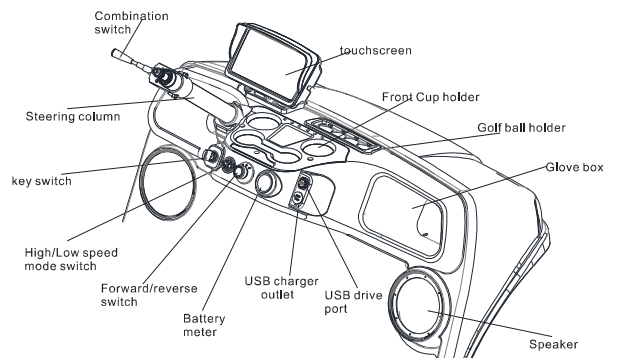

OPERATION AND CONTROLS

Read carefully all the safety statements before attempting any procedure.

DANGER

OPERATING THE VEHICLE WHILE OCCUPANTS ARE NOT FULLY SEATED CAN CAUSE SERIOUS PERSONAL INJURY OR DEATH. START THE VEHICLE ONLY WHEN ALL OCCUPANTS ARE FULLY SEATED. FALLING OBJECTS CAN CAUSE PROPERTY DAMAGE, SERIOUS PERSONAL INJURY, OR DEATH. DO NOT OPERATE THE VEHICLE WHERE THERE IS A RISK OF FALLING OBJECTS. DO NOT LET A PASSENGER HOLD A CHILD ON THEIR LAP WHILE THE VEHICLE IS IN OPERATION. DO NOT LET PASSENGERS RIDE IN THE VEHICLE OR TRAILER BEING TOWED.

WARNING

KEEP AWAY FROM DROP-OFFS, STEEP SLOPES, AND UNSTABLE SURFACES. SUDDEN STARTS, STOPS, AND TURNS CAN CAUSE PROPERTY DAMAGE AND SERIOUS PERSONAL INJURY. PREVENT SUDDEN STARTS, STOPS, AND TURNS. FAILURE TO CORRECTLY MAINTAIN THE VEHICLE AND MAKE NECESSARY REPAIRS CAN DECREASE VEHICLE PERFORMANCE, CAUSE A FIRE, PROPERTY DAMAGE, SERIOUS PERSONAL INJURY, OR DEATH. IF PROBLEMS ARE FOUND DURING SCHEDULED INSPECTION OR SERVICE, OPERATE THE VEHICLE ONLY WHEN REPAIRS ARE MADE. MAKE SURE THAT ALL PASSENGERS CAN SECURE THEMSELVES IN THE VEHICLE BEFORE VEHICLE OPERATION. TO PREVENT SERIOUS PERSONAL INJURY, KEEP ENTIRE BODY IN THE VEHICLE DURING OPERATION. THE VEHICLE IS NOT SPECIALLY EQUIPPED FOR HANDICAPPED PERSONS. BEFORE VEHICLE OPERATION, MAKE SURE THAT ALL PERSONS COMPLY WITH THE WARNINGS AND OPERATING INSTRUCTIONS. INCORRECT OPERATION OF THE VEHICLE CAN CAUSE DECREASED VEHICLE PERFORMANCE, PROPERTY DAMAGE, SERIOUS PERSONAL INJURY, OR DEATH. TO PREVENT FALLS FROM THE VEHICLE, PASSENGERS MUST STAY SEATED AND ALWAYS HOLD ON TO HAND HOLDS OR HANDRAILS WHEN THE VEHICLE IS IN OPERATION. THE DRIVER MUST KEEP BOTH HANDS ON THE STEERING WHEEL WHEN THE VEHICLE IS IN OPERATION. A SHARP TURN AT HIGH SPEEDS CAN CAUSE A ROLL-OVER, FALL, PROPERTY DAMAGE, AND SERIOUS PERSONAL INJURY. OPERATE THE VEHICLE SLOWLY IN TURNS. UNINTENDED VEHICLE OPERATION CAN CAUSE SERIOUS PERSONAL INJURY OR DEATH. BEFORE LEAVING THE VEHICLE OR DURING VEHICLE MAINTENANCE, DISABLE THE VEHICLE. THE VEHICLE IS NOT DESIGNED TO MEET CHILD SAFETY SEAT COMPATIBILITY REQUIREMENTS. CHILDREN REQUIRING A CHILD SAFETY SEAT MUST NOT RIDE ON THE VEHICLE. COMPLY WITH STATE AND LOCAL LAWS PERTAINING TO CHILD SAFETY.

CAUTION

OPERATE THE VEHICLE ONLY FROM THE DRIVERS SEAT. OPERATE THE VEHICLE ONLY IN SPECIFIED AREAS. ONLY AN AUTHORIZED LICENSED DRIVER CAN OPERATE THE VEHICLE. ONLY OPERATE THE VEHICLE IN COMPLIANCE WITH LOCAL AND STATE LAWS. USE CAUTION WHEN OPERATING THE VEHICLE IN THE PRESENCE OF HIGHER-SPEED VEHICLES, IN CONGESTED AREAS, OR ON UNIMPROVED SURFACES.

OPERATION AND CONTROLS

Read carefully all the safety statements before attempting any procedure.

PRE-OPERATION SAFETY AND PERFORMANCE INSPECTION

Use the pre-operation checklist to inspect the operational condition and performance of the vehicle. If a vehicle is found to be in bad operational condition, remove it from operation. Removal from operation will prevent more damage to the vehicle and prevent a serious injury. If the vehicle is out of operation, speak with your dealer for maintenance and repairs.

PRE-OPERATION CHECKLIST

INSPECTION ITEMS	INSPECTION PROCEDURES
BATTERY	Before initiate using vehicle, the batteries should be fully charged, Replace the bad/broken/damaged parts while inspection.
BRAKE	Check the brake pedal, when stepped it should be flexible and feels firm. And it returns to its original position with flexibility when released
ACCELERATOR PEDAL	Check the accelerator pedal, when stepped and released it should returns to its original position with full flexibility.
TIRES	Check the tires' pressure, pressure is around 20psi. Check tires surface, remove any embedded objects you can find. Be sure no cracks or other damages to the tires, defective tires may cause accident while driving.
STEERING	Pull the steering wheel up and down, check the tightness of steering wheel. Rotate the steering wheel right and left. Be sure no excessive free play and rattling sound.
REVERSER WARNING BEEPER	Check the reverse beeper, when the direction selecting switch be set at "REV", it should beep soundly
LIGHTS	Check the signal lights, the brake lights and turning lights should be in proper working condition.



OPERATION AND CONTROLS

Read carefully all the safety statements before attempting any procedure.

PRE-OPERATION SAFETY AND PERFORMANCE INSPECTION

Before initiate using vehicle, the batteries should be fully charged.

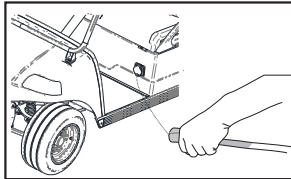

Check the accelerator pedal ,when stepped and released it should returns to its original position with full flexibility .

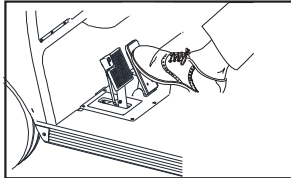

Check the brake pedal , when stepped it should be flexible and feels firm . And it returns to its original position with flexibility when released.

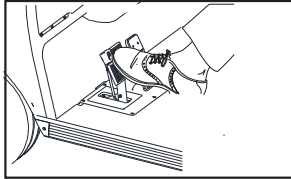

Check the tires' pressure ,it should be inflated until the internal pressure is around 20PSI (138kpa)

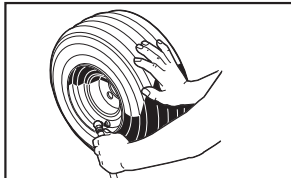

Check the signal lights , the brake lights and turning lights should be in proper working condition .

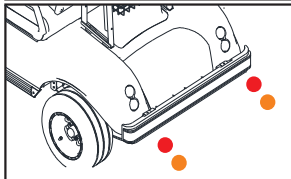

OPERATION AND CONTROLS

Read carefully all the safety statements before attempting any procedure.

PRE-OPERATION SAFETY AND PERFORMANCE INSPECTION

Check the reverse beeper ,when the direction selecting switch be set at "REV", it should beep soundly

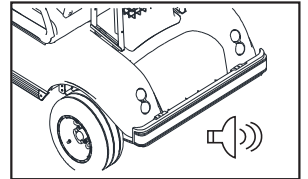

Check the tires' surface , remove any embedded objects you can find . Be sure no cracks or other damages to the tires ,defective tires may cause accident while driving .

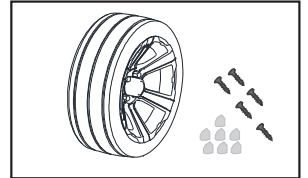

Check the lubricant capacity the rear axle contains, use a cleaned stick , stick it into the rear axle and it reach the bottom , pull it out check the depth.The amount of oil should be around 0.8L.

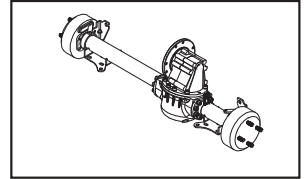

Pull the steering wheel up and down ,check the tightness of steering wheel .Rotate the steering wheel right and left. Be sure no excessive free play and rattling sound .

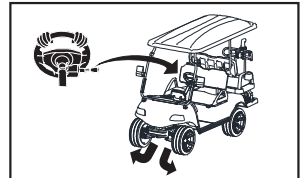

Check the tightness of the battery cables , make sure all the nuts are solidly tight. Loose nuts on the battery will cause big spark while operating .

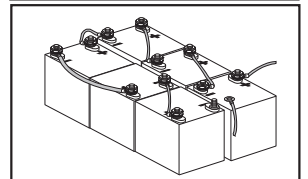

OPERATION AND CONTROLS

Read carefully all the safety statements before attempting any procedure.

ACCELERATOR PEDAL

The accelerator pedal is used to increase and maintain the speed of the vehicle. Apply slow and steady pressure to the accelerator pedal to start the motor and accelerate the vehicle. When you release the accelerator pedal the motor will decrease the speed of the vehicle.

⚠ DANGER

Do not engage the accelerator pedal rudely, sudden or accidental accelerating can cause vehicle to suddenly move and cause severe injury or death.

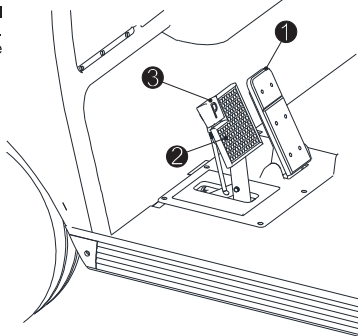

Mechanical Brake

- ① Accelerator pedal
- ② Brake pedal
- ③ Foot-Parking brake

BRAKE PEDAL

The brake pedal is used to decrease speed or stop the vehicle. It is the left pedal on the floorboard. HDK vehicles have two styles of brake system: Mechanical and Hydraulic brake.

⚠ WARNING

When loading the cargo or towing a vehicle or trailer, the payload will be increasing the braking distance required to slow or stop the vehicle.

FOOT PARKING BRAKE PEDAL (MECHANICAL BRAKE)

The Foot Parking brake pedal is used to keep the vehicle in static on the ground or on the hills. Foot parking brake pedal is only used in mechanical brake system.

⚠ WARNING

Make sure the parking brake pedal locks in place with positive click, and release freely when pressing accelerating pedal.

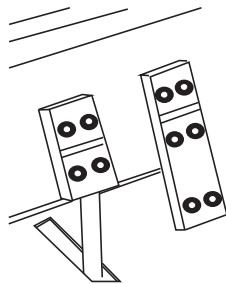

Hydraulic Brake

OPERATION AND CONTROLS

Read carefully all the safety statements before attempting any procedure.

HAND PARKING BRAKE (HYDRAULIC BRAKE)

The Hand parking brake is used to keep the vehicle in static on the ground or on the hills. Hand parking brake is only used in hydraulic brake system.

⚠ WARNING

Make sure the hand parking brake be pulled up enough to stop the vehicle parking on a slope and not roll back.

NOTICE

Some vehicles with hydraulic braking do not have the hand parking brake lever, instead the vehicles will be equipped with motor brake which has the same function as hand parking brake.

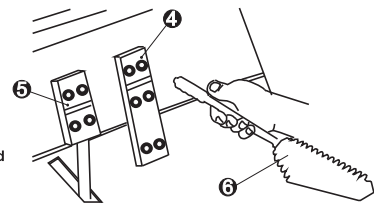

Hydraulic Brake With Hand Parking Brake

- ④ Accelerator pedal
- ⑤ Brake pedal
- ⑥ Hand Parking brake

MOTOR BRAKE (Optional)

Some vehicles are equipped with an motor brake which is used to park the vehicles automatically. When the vehicle stops on the flat ground or on the hills, The parking brake will be released when the vehicle is in F (Forward) or R (Reverse) position and engaging the accelerator pedal.

⚠ WARNING

If you have a motor brake on your golf cart, make sure to unlock the motor brake mechanically before towing the golf cart, otherwise it will ruin the motor, rear differential and motor brake.

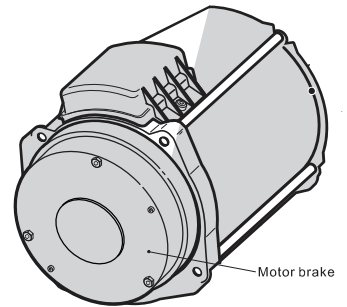

Motor Brake



OPERATION AND CONTROLS

Read carefully all the safety statements before attempting any procedure.

KEY SWITCH CONTROL

The key switch controls the vehicle's electrical system. The key switch has two positions : ON/OFF.

ON: When switched to "ON" position, all the electrical system and accessories can be used and operated.

OFF: When switched to "OFF" position, all the electrical systems are disabled.

Key switch

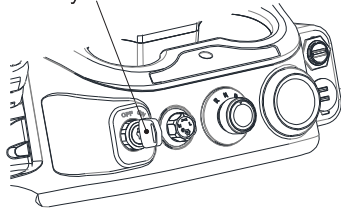

WARNING

THE KEY SWITCH CAN BE USED TO STOP THE VEHICLE IN AN EMERGENCY. DO NOT BREAK OFF KEY IN THE KEY SWITCH.

FORWARD/NEUTRAL/REVERSE CONTROL (D/N/R Knob switch)

FORWARD (D):

When the knob is switched to "D" position, the cart will move forward direction when the driver presses the accelerating pedal with key switch on.

NEUTRAL (N):

When the knob is switched to "N" position, the cart will not move in when the driver presses the accelerating pedal with key switch on.

REVERSE (R):

When the knob is switched to "R" position, the cart will move reverse direction when the driver presses the accelerating pedal with key switch on. And will activate the reverse buzzer.

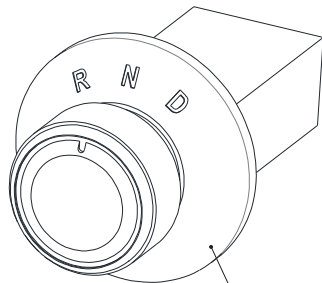

Forward & Reverse switch

OPERATION AND CONTROLS

Read carefully all the safety statements before attempting any procedure.

HIGH/LOW SPEED MODEL SELECTING SWITCH (Optional)

The High/Low speed mode selecting switch is located on the right side of key switch on the dash board.

- Selecting "H" mode will activate the cart to run at High max speed.
- Selecting "L" mode will activate the cart to run at low max speed.

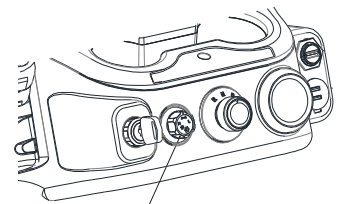

High/Low speed mode switch

USB DRIVE PORT & USE CHARGER OUTLET

USB DRIVE PORT:

The USB drive port is used for transiting the data from USB flash drive to touchscreen media.

USB CHARGER OUTLET:

- 5V 2.1A
- 5V 1A

The USB charger outlet is used for providing 5V power from the vehicles to charge small electrical gadgets, such as cell phone, iPad ... etc.

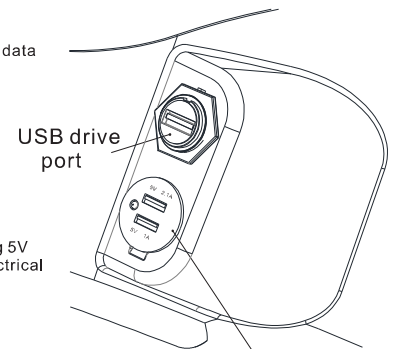

USB Charger outlet



OPERATION AND CONTROLS

Read carefully all the safety statements before attempting any procedure.

COMBINATION SWITCH CONTROL

The headlight and turning signal switch is located on the steering column under the steering wheel. The switch lever is located on the driver side.

FRONT HEADLIGHT CONTROL

Pushing the lever down will activate the front headlights.

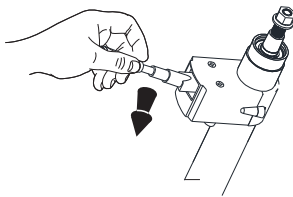

TURNING SIGNAL LIGHTS CONTROL

Pushing the lever up will activate the right turning lights, including front and rear turning lights

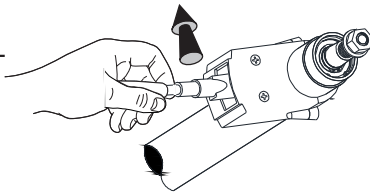

TURNING SIGNAL LIGHTS CONTROL

Pulling the lever down will activate left turning lights, including front and rear turning lights..

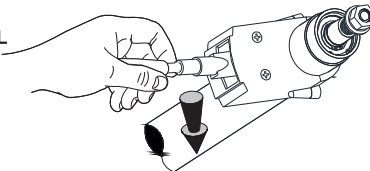

HORN CONTROL

Press the horn button (on the end of switch lever) will activate the horn.

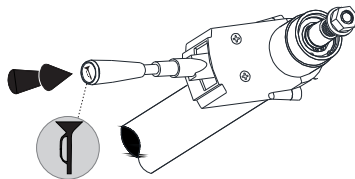

OPERATION AND CONTROLS

Read carefully all the safety statements before attempting any procedure.

MOTOR BRAKE RELEASE SWITCH (Electrical) (Optional)--Old Type (Optional)

The motor brake releasing switch is located under the front seat cushion, on the passenger side. You can lift up the front seat cushion and find the switch. See image on the right.

The switch is used for releasing the motor brake manually when the vehicle needs to be towed by trailer or pushed by people. Press down the switch to release the motor brake. Press up the switch to activate the motor brake.

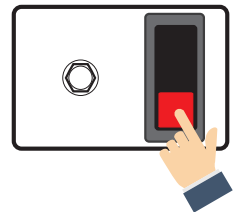

NOTICE

Turn on the key switch before operating the switch to engage the function.

MOTOR BRAKE RELEASE SCREWS (Mechanical) --Old Type (Optional)

Use the Allen wrench (M5) to tighten 2pc small hexagonal socket head screws located on the left end face of AC motor, then it will disable the Electromagnetic Brake (EM-Brake) function, and release EM-brake disc. Then the vehicles can be towed or pushed freely.

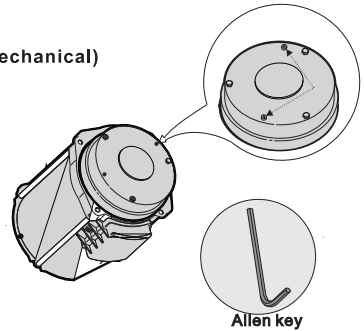

MOTOR BRAKE RELEASE LEVER (Mechanical) --New Type(Optional)

For new type motor brake releasing lever, to release the motor brake, press the plate on the motor brake mechanism and then pull the releasing lever to the right side on the image to release the motor brake, then the vehicle can be pushed or towed freely.

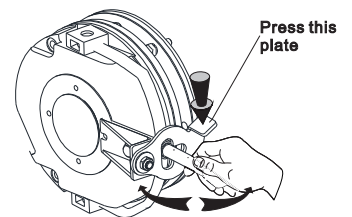

Press this plate

OPERATION AND CONTROLS

Read carefully all the safety statements before attempting any procedure.

HOW TO OPERATE A CART

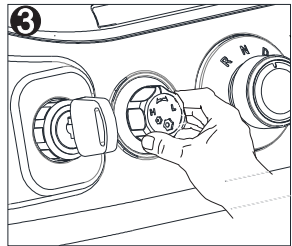
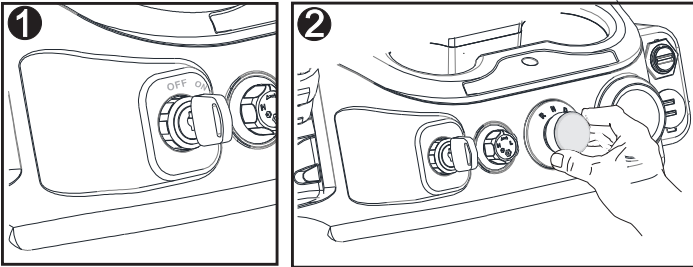
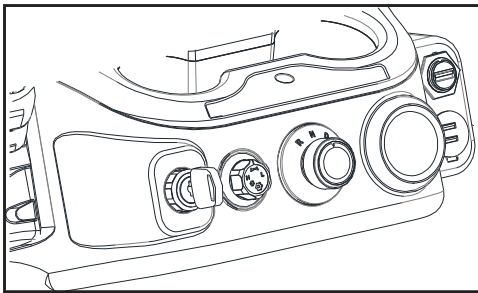

- 1 Turn on the key switch
- 2 Place the D/N/R switch to "D" or "R" position
- 3 Set High/Low switch to "H" or "L"

OPERATION AND CONTROLS

Read carefully all the safety statements before attempting any procedure.

HOW TO OPERATE A CART (Mechanical brake)

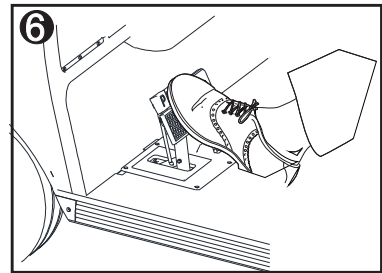
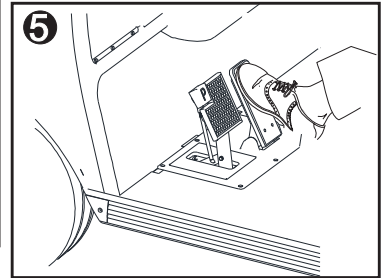
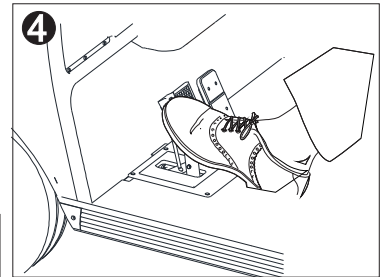
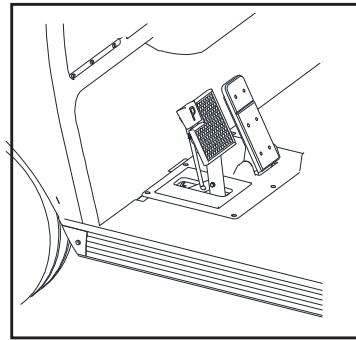

- 4 Release the parking brake
- 5 Press the accelerating pedal
- 6 Use the brake pedal to control the speed or stop the vehicle

OPERATION AND CONTROLS

Read carefully all the safety statements before attempting any procedure.

HOW TO OPERATE A CART (Hydraulic brake)

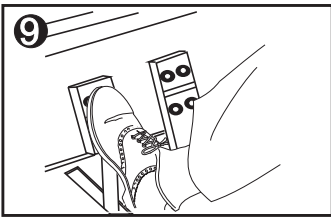
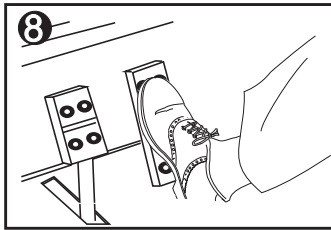
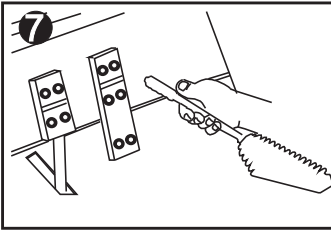
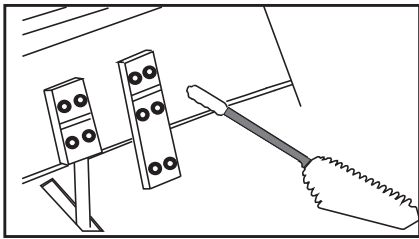

- 7** Release the parking brake handle
- 8** Press the accelerating pedal
- 9** Use the brake pedal to control the speed or stop the vehicle

OPERATION AND CONTROLS

Read carefully all the safety statements before attempting any procedure.

ALUMINUM CARGO BOX & FLAT BED

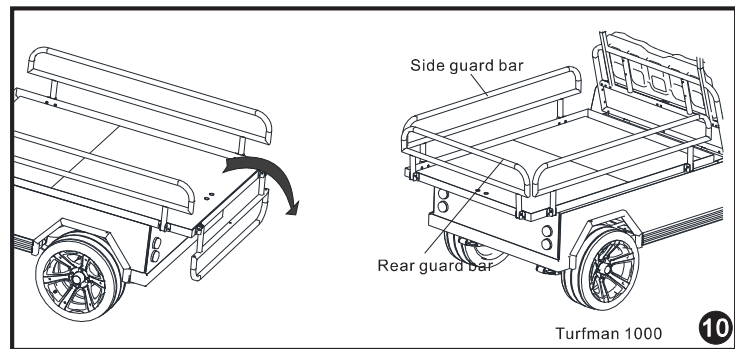

- 10** Lift up the side & rear guard bars of flat bed, then flip it down to load or unload the cargos.

- 11** Grab the lifting handle, then lift up the aluminum cargo box.

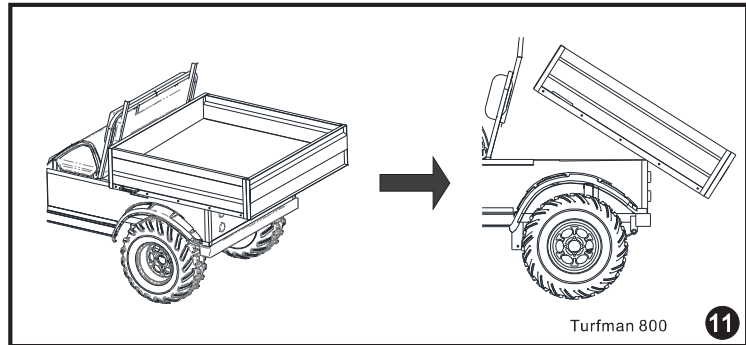

BATTERY

Read carefully all the safety statements before attempting any procedure.

WARNING

Improper handling of batteries and electrical components can result in serious injury or death.

Do not remove the battery pack cover. Do not attempt to remove batteries or battery cables. Do not use the battery pack without the control module installed. All battery and electrical service must be performed by an authorized service facility and personnel.

All tools used in or around the battery pack area should be insulated. Do not intentionally cause a short to the power terminal (B+, B-) with a metallic object.

Do not cut, tear or remove the seal tape. Do not disassemble or modify the design, including the electrical circuit, of the battery pack or control module.

To prevent the risk of battery explosion, keep all flammable materials, open flames or sparks away from the batteries. Do not leave the battery pack near a fire or heat source. Do not throw Lithium-Ion batteries into a fire. Do not apply heat to any part of the battery pack or battery management module with a soldering iron. Do not place the battery pack in a microwave oven, dryer or high-pressure container.

Do not attempt to operate the vehicle or charge the battery pack at temperatures above 140°F (60°C).

Do not immerse or throw the battery pack in water. Do not pressure wash the battery pack.

Do not puncture the battery pack or control module. Do not strike the battery pack with a hammer or heavy weight. Do not step or stand on the battery pack. Do not throw or drop the battery pack on hard surfaces.

If the battery pack terminals are contaminated or dirty, clean them with a dry cloth before using the battery pack.

Keep the battery pack and control module away from static electricity.

NOTICE

INCORRECT STORAGE CAN CAUSE BATTERY DAMAGE, PERMANENT LOSS OF BATTERY CAPACITY, OR CAUSE THE BATTERY TO BE UNSERVICEABLE. A FULLY DISCHARGED BATTERY PUT IN STORAGE WILL MAKE THE BATTERY PERMANENTLY UNSERVICEABLE. PUT THE BATTERY ON CHARGE DURING EXTENDED STORAGE. DO NOT EXCEED THE STORAGE TEMPERATURE LIMITS. DO NOT PUT A FULLY DISCHARGED BATTERY IN STORAGE. INCORRECT STORAGE WILL VOID THE BATTERY WARRANTY.

BATTERY

Read carefully all the safety statements before attempting any procedure.

LITHIUM BATTERY OVERVIEW

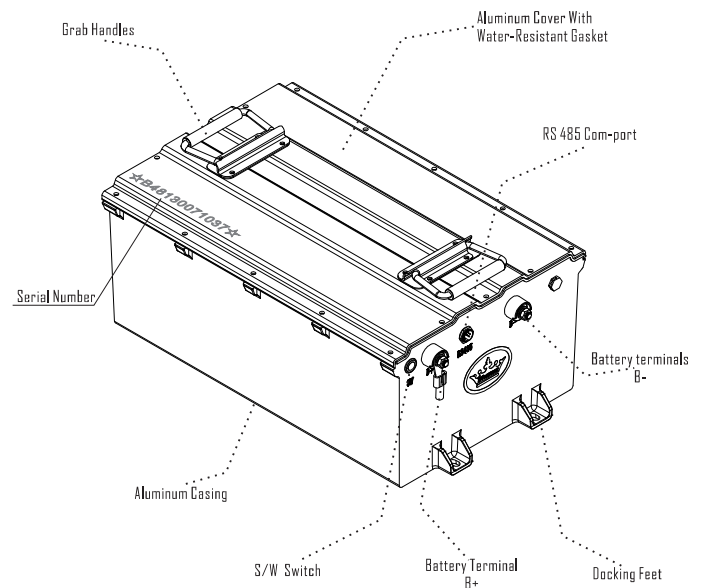

LITHIUM BATTERY SPEC LABEL

EVOLUTION ELECTRIC VEHICLES LITHIUM-ION BATTERY	
Battery Type	LiFePO4
Voltage	48V
Energy	5.28KWh
Capacity	110AH
Weight	109.7lbs(49.9kg)

LITHIUM BATTERY WARNING LABEL



MODEL	VOLTAGE (V)	CAPACITY (Ah)
L4860	48V	60AH
L48110	48V	110AH
L48130	48V	130AH
L48180	48V	180AH

BATTERY

Read carefully all the safety statements before attempting any procedure.

LEAD ACID BATTERY OVERVIEW

Batteries loaded on HDK vehicles ,according to different configurations, customers who purchase HDK vehicles can have two different batteries options: Trojan T875 (8V)/T105(6V), and HDK lithium battery, which has the four models normally: L4860, L48110, L48130, L48165.

I. Lead acid battery (Trojan)

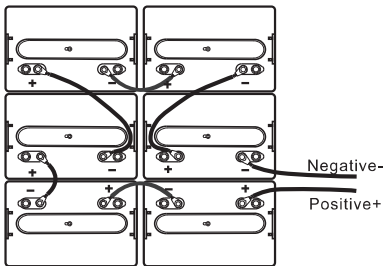

Trojan T875 x 6pc

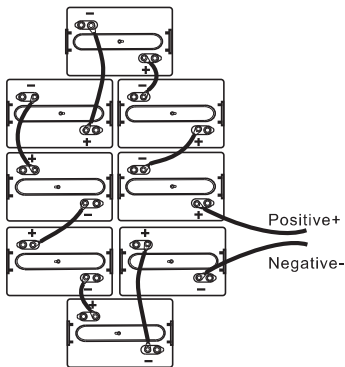

Trojan T105 x 8pc

BATTERY

Read carefully all the safety statements before attempting any procedure.

BATTERY METER

For Basic battery SOC (state of charge) information ,check the battery level display module .

LITHIUM BATTERY METER

SOC indication in progress bar
1 means 100%
0 means 0%

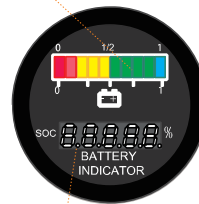

1 SOC indication in percentage

LEAD ACID BATTERY METER

SOC indication in progress bar
1 means 100%
0 means 0%

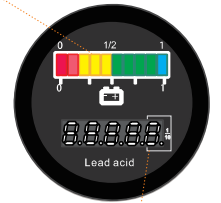

2 Vehicle total running time in Hours

Each LED light grid indicates 10% power of battery pack.

-Blue LED light indicates 90%-100% battery power.

-Four green LED lights indicate 60%~90% battery power.

-Three Yellow LED lights mean 30%-50% battery power left

-Last two red LED Lights indicate only 0-20% battery power left, and the battery pack needs to be charged immediately.

1 The LED digital in the below tablet indicate the SOC percentage of lithium battery pack. (For lithium battery meter only).

2 The LED digital in the below tablet indicate the vehicle total running time of the golf cart. (For lead-acid battery meter only)

BATTERY

Read carefully all the safety statements before attempting any procedure.

BATTERY MAINTAINANCE

•Watering the batteries(For lead acid battery only)

Deep-cycle ooded/wet batteries need to be watered periodically. The frequency depends on battery usage, charging and operating temperature. Check new batteries every few weeks to determine the watering frequency for your application. It is normal for batteries to need more watering as they age.

1. Use only distilled or deionized water. Tap water can contain contaminants that will damage the battery. Also, be aware that water can pick up impurities from containers, piping.
2. Fully charge the batteries prior to adding water. Only add water to discharged or partially charged batteries if the plates are exposed. In this case, add just enough water to cover the plates and then charge the batteries. Once completed, continue with the watering procedure below.
3. Check the electrolyte levels by removing the vent caps and placing them upside down so that dirt does not accumulate on the underside of the cap.
4. If the electrolyte level is barely covering the plates, add distilled or deionized water to the proper level as illustrated. After adding water, secure vent caps back onto batteries.

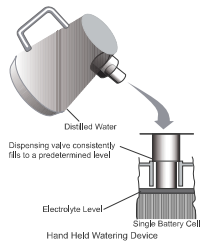
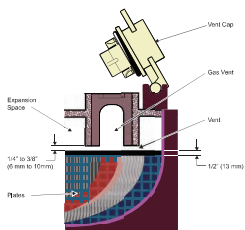

DO NOT overfill batteries. The charging cycle will expel electrolyte and result in component damage.

BATTERY

Read carefully all the safety statements before attempting any procedure.

BATTERY MAINTAINANCE

•Clean the batteries (Both for lead-acid and lithium battery)

Check the battery for cleanliness at regular intervals and keep terminals and connectors free of corrosion. Terminal corrosion may adversely affect the performance of the battery and present a safety hazard.

1. For flooded batteries, check that all vent caps are secured properly on the battery.
2. Clean the top of the battery, terminals, and connections with a cloth or non-metallic brush, and a solution of baking soda and water comprised of 1 cup of baking soda to 1 gallon of water (60 ml of baking soda per liter of water). Do not allow cleaning solution to get inside the battery.

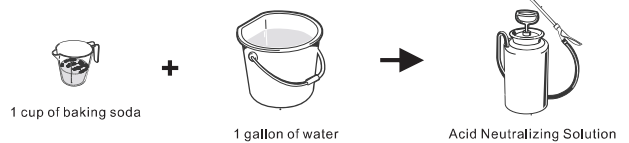

3. Rinse with water and dry with a clean cloth.
4. Apply a thin coat of terminal protector spray which can be purchased through your local battery dealer.
5. Keep the area around batteries clean and dry.



The electrolyte in a storage battery is an acid solution which can cause severe burns to the skin and eyes. Treat all electrolyte spills to the body and eyes with extended flushing with clear water. Contact a physician immediately. Always wear a safety shield or approved safety goggles when adding water or charging batteries. Always wear gloves to protect person from acid corrosion. Always remember to take precautions while conduct any operations on batteries or handle battery.



Goggle



Anti-Acid gloves



Insulated tools

BATTERY CHARGER

Read carefully all the safety statements before attempting any procedure.

WARNING

INCORRECT CONNECTION OF THE AC CORD CAN CAUSE A FIRE OR AN ELECTRICAL SHOCK. DO NOT USE AN ADAPTER TO CONNECT THE AC CORD INTO A TWO-PRONG POWER SOURCE. CONNECT THE AC CORD TO AN APPROVED POWER SOURCE. CONNECTION OF THE AC CORD TO AN INCORRECT RECEPTACLE CAN CAUSE A FIRE, ELECTRICAL SHOCK, PROPERTY DAMAGE, SERIOUS PERSONAL INJURY, OR DEATH. CONNECT THE AC CORD TO AN APPROVED POWER SOURCE AND RECEPTACLE. DO NOT LET THE BATTERY CHARGER BECOME WET. KEEP THE BATTERY CHARGER DRY.

CHARGER SPECIFICATION

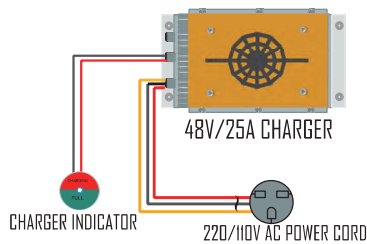

Battery pack rated voltage	48V
Maximum charger output	68V
AC input voltage range	85-270VAC, 45-65Hz
AC input current value	11.5A@120VAC, 6.1A@220VAC
Power factor	0.99
Charger efficiency	95%
Noise	45dB
IP Class	IP67
Weight	9.3lb (4.2kg)
Operating temperature	-86°F to 149°F (-30°C to 65°C)
Storage temperature	-104°F to 203°F (-40°C to 95°C)

BATTERY CHARGER

Read carefully all the safety statements before attempting any procedure.

CHARGER LED DISPLAY

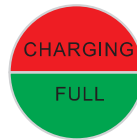

LED Light	Indication
Red LED light flashing	Charging
Solid Green light	Charge completely
Red and Green flashing in order	Refer to the Troubleshooting table

LED FAULT CODES

Flashes (— means pause 1s)	Cause	Solution
	No load	Check if happens: the connection of battery and charger is loose, the battery defective, or the battery voltage is too low.
	Over voltage or over current	If the error occurs after restart, return it to factory repair.
	The ambient temperature is too high or too low	Please check if the ambient temperature is too high and if ventilation is good and the battery temp sensor is good
	Charger overheating	Please check if ambient temperature is too high and if ventilation is good.
	Output Under-Voltage	Please return it to the factory. Replace new charger
	Input AC abnormality	Please check the input voltage and the plug poor contact.
	After anyone of the mentioned faults above repeats five times, the fault code appears.	Re-up electricity, match the indicator state to the mentioned faults above then get the corresponding solution.



BATTERY CHARGER

Read carefully all the safety statements before attempting any procedure.

HOW TO USE CHARGER

WARNING

TO DECREASE THE POSSIBILITY OF ELECTRICAL SHOCK OR ELECTROCUTION, MAKE SURE THE CHARGER PLUG IS NOT DAMAGED. THE POWER AC CORD HAS A PLUG WITH GROUND POST. DO NOT MOVE, CUT OR BEND THE GROUND POST.

1. Inspect the charger cord to check if there is broken or damaged on the power AC cord and cable. Replace the broken AC power cord.
2. Plug the AC charge handle into the vehicle receptacle completely.
3. Plug the Power AC cord into the ground power completely.
4. The charger will automatically start in several seconds after plugging in the AC power cord.
5. The charger will automatically stop when the batteries are fully charged.
- 6- Remove the AC charge cord before operating the vehicle.

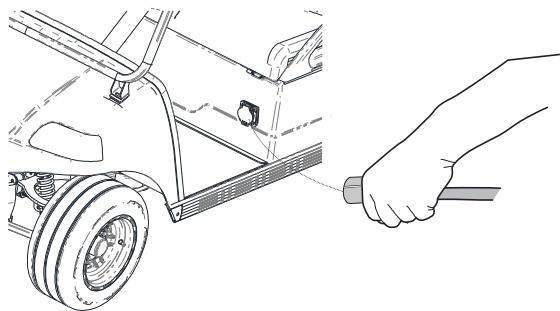

TOUCHSCREEN OPERATION

Read carefully all the safety statements before attempting any procedure.

CHARGER MAINTENANCE

WARNING

IF THE PLUG PINS ARE BENT, SPEAK WITH YOUR LOCAL DEALER OR DISTRIBUTOR FOR REPLACING. DO NOT TRY TO REPAIR THE AC CORD PLUG OR PINS.

ELECTRICAL CORDS

Examine electrical cords for wear and damage before use. Immediately replace electrical cords for:

- Cracks
- Cuts
- Frayed wiring
- Insulation damage
- Loose connections
- Splices

ELECTRICAL PLUGS AND RECEPTACLES

Examine electrical plugs for wear and damage before use. Immediately replace electrical plugs for:

- Bent pins
- Corrosion
- Cracks
- Loose connections
- Missing pins

CLEAN THE ELECTRICAL PLUGS AND RECEPTACLES

1. Disconnect the AC cord from the power source.
2. Disconnect the AC cord from the battery charger.
3. Disconnect the DC cord from the vehicle charger receptacle.
4. Apply electrical contact cleaner to the electrical plugs and receptacles. Refer to the manufacturer's instructions.
5. Clean the electrical plugs and receptacles.
6. Lightly lubricate the electrical plugs and receptacles with WD-40®.



TOUCHSCREEN OPERATION

Read carefully all the safety statements before attempting any procedure.

TOUCHSCREEN OVERVIEW AND INTRODUCTION

This touchscreen is kind of multi-functional device that includes different functions and operations. All functions and operations are listed as below:

- Radio
- Music
- Movie
- Bt Phone
- Back-up Camera
- Bt Music
- Setting
- Picture
- Car info

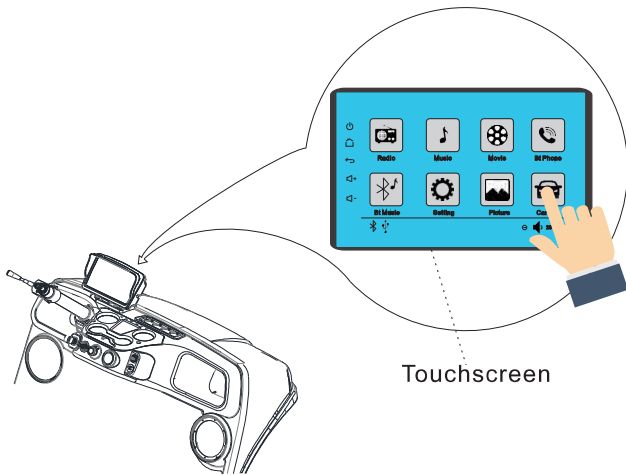

TOUCHSCREEN OPERATION

Read carefully all the safety statements before attempting any procedure.

TOUCHSCREEN OPERATION

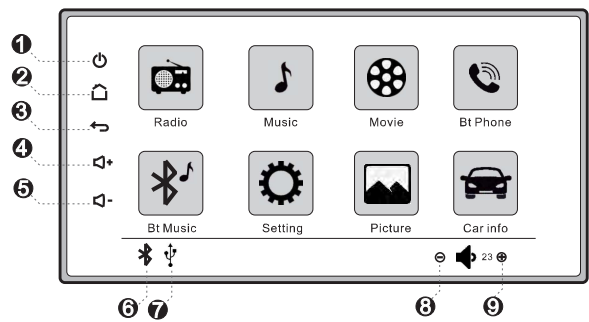

- ❶ Power Button: Turn off/on the touchscreen.
- ❷ Home Button: Press this button to go back home screen.
- ❸ Back Button: Press this button to go back upper level Interface.
- ❹ Volume Up Button: Press button to increase the volume
- ❺ Volume Down Button: Press button to reduce the volume
- ❻ Bluetooth indicator: Icon will turn blue when connecting to blue-tooth
- ❼ USB Drive indicator: Icon will turn blue when connecting to USB drive disk
- ❽ Volume Down Button: Press button to increase the volume.
- ❾ Volume Up Button: Press button to reduce the volume.

TOUCHSCREEN OPERATION

Read carefully all the safety statements before attempting any procedure.

RADIO

>Radio stations displaying Show present radio channel Hz.

>Radio stations store:
After getting a channel, press any square buttons for 5s, then the channel will be stored in the tablet.

>Automatically radio channel searching:
Press the button, the radio will search the channel automatically.

>Band switch:
There are three bands of stations, press this button, the radio will be switched over during FM1/FM2/FM3.

>Manual channel tuning backward.

>Manual channel tuning forward.

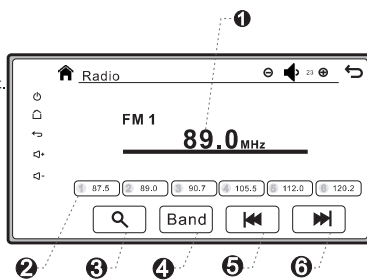

MUSIC MOVIE & PICTURE

Press the "Music" or "Movie" or "Picture" button, the screen will enter into the "Movie" or "Picture" interface as pictured below. Before pressing the button, be sure to plug into the USB flash drive first.

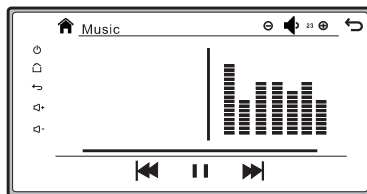
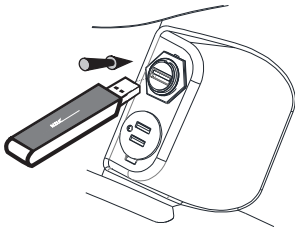

NOTICE

The music/movies/pictures must be prestored in the USB flash drive disk.
These music/movies/ pictures will be played after you press the buttons on the touchscreen.

TOUCHSCREEN OPERATION

Read carefully all the safety statements before attempting any procedure.

BT PHONE OPERATION

Press the " Bt Phone " button, the screen will get into the "Bt Phone" interface as pictured below.

- ① Connect the bluetooth with cell phone.
- ② Disconnect the bluetooth with cell phone.
- ③ Connecting status of cell phone display window:
Four different status:
-No Connection
-Connection
-Call out
-Speaking
- ④ Delete button
- ⑤ Call button
- ⑥ Ending call button
- ⑦ Switch the speakers of calling between cell phone and vehicle-mounted bluetooth
- ⑧ Dial keypad

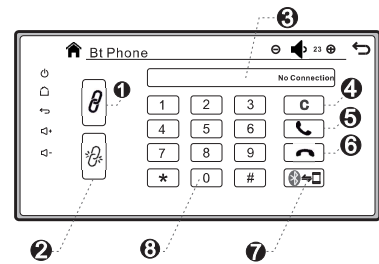

How To Connect the bluetooth between cell phone and vehicle?

- (1) Open the cell phone bluetooth function.
- (2) Press the button to enter into the "Bt Phone" interface.
- (3) Search the available bluetooth device on the cell phone, in the touchscreen bluetooth named "DTLY-JYT".
- (4) Press the "DTLY-JYT", the cell phone will jump out the interface of "bluetooth pairing request", and request the user to enter the pairing PIN code: (The PIN code is "0000").
- (5) After pairing successfully, it will show "connected" under the "DTLY-JYT" on the cell phone, and the status display window on the touchscreen will show "Connection". That means the bluetooth is connected successfully.

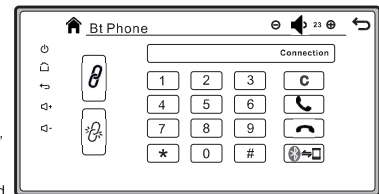

TOUCHSCREEN OPERATION

Read carefully all the safety statements before attempting any procedure.

BT PHONE OPERATION

After connecting the bluetooth with cell phone on the Bt phone, then the Bt Music function will be activated. Press the " Bt Music " button, the screen will get into the " Bt Music " interface as pictured. Open the music function on the cell phone and play the music, then the touchscreen Bt Music will play the same music synchronously with the cell phone.

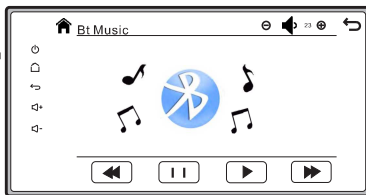

SETTING

Press the " Setting " button, the screen will get into the "Setting" interface as pictured.

Four settings:

- >Language set : English or Chinese.
- >Wallpaper: Four different wallpaper optional.
- >Version Show: Touchscreen software version.
- >Reset: Reset the touchscreen to default status.

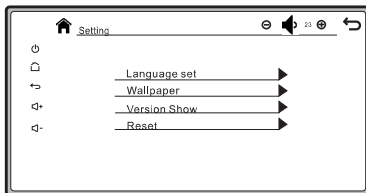

CAR INFO OPERATION

Press the " Car inor " button, the screen will get into the "Setting" interface as pictured below. It is default interface, when turning on the key switch, the touchscreen will show Car info interface automatically.

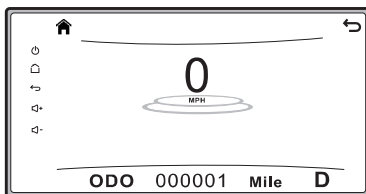

TOUCHSCREEN OPERATION

Read carefully all the safety statements before attempting any procedure.

CAR INFO OPERATION



How To change the speed unit between km/h and mph?

- Press the "Volume up" button  to change speed unit.



How To change the display between ODO and TRIP

- Press the "Volume up" button  to change speed unit.

BACK-UP CAMERA OPERATION

When the direction knob switching to "R" (Reverse), the screen will show back-up camera image to guide the driver to reverse the vehicle.

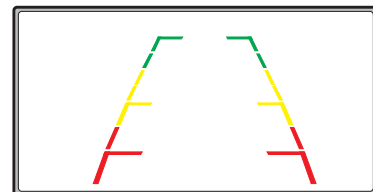

SPEEDOMETER

Read carefully all the safety statements before attempting any procedure.

SPEEDOMETER OVERVIEW



- ❶ **Motor Rotation Speed:** shown on the top of speedometer (for example: when the speedometer shows 3 then the motor rotation speed is 3000rpm)
- ❷ **Vehicle running speed:** Shows current running speed of vehicle, with unit km/h or Mph.
- ❸ **TRIP (Single trip of distance):** Records the mileage for a single trip.
- ❹ **ODO:** Odometer, Records the mileage for total trips.
- ❺ **RTT:** Total driving time of cart operation.

Speedometer LED Indicators:

- ❻ Headlight Indicator
- ❼ Forward Indicator---F
- ❸ Reverse Indicator---R
- ❹ Braking Indicator
- ❺ Left Turning Indicator
- ❻ Right Turning Indicator

SPEEDOMETER

Read carefully all the safety statements before attempting any procedure.

SPEEDOMETER OPERATION



I. To change the display of "TRIP" or "ODO" mode,

- >Press "Mode" button twice to change to "TRIP" mode;
- >Press "Mode" button three time to change to "ODO" mode.

II. To change the speed unit from km/h to mph, or from mph to km/h:

- 1) First press the "Mode" button three times to change to "ODO" mode.
- 2) Secondly press the "RESET" button for 5 seconds, then the unit will be changed from mph to km/h or from km/h to mph.

III. To change the display to RTT, total driving time:

- Press "Mode" button one time to change to "RTT" then it will display total driving time.



TIRE OPERATION

Read carefully all the safety statements before attempting any procedure.

TIRE OPERATION

WARNING

DO NOT OVER INFLATE THE TIRES. EXCESS PRESSURE CAN CAUSE THE TIRE EXPLODE.
TO DECREASE THE RISK OF TIRE EXPLOSION, ADD SMALL AMOUNTS OF AIR TO THE TIRE AT INTERVALS TO SEAT THE TIRE BEADS. OVER INFLATION OF SMALL TIRES CAN OCCURS IN A FEW SECONDS.
PROTECT FACE AND EYES WHEN REMOVING THE TIRE VALVE CORE.
USE ONLY SOCKETS MADE FOR IMPACT WRENCHES TO DECREASE THE RISK OF INJURY CAUSED BY A BROKEN SOCKET.
DO NOT USE TIRES THAT HAVE INFLATION PRESSURE LESS THAN THE TIRE PRESSURE RECOMMENDED.

NOTICE

Always follow the cross-sequence pattern when you install the lug nuts to make sure the wheel is evenly seated against the hub.

Tools list

Lug Wrench, M19.....	1
Impact Wrench.....	1
Impact Socket, M19.....	1
Torque Wrench.....	1

The general recommended tire inflation pressure is 20 psi, but the tire inflation pressure can be changed according to the specific terrain condition.

All four tires must have the same pressure for the best control qualities. Always put the valve stem cap back after checking or inflate the tires.

Use a tire plug to repair small holes in the thread part of the tires. For large holes or cuts, replace the whole tire.

- >With the valve stem to the outside of wheel, install the wheel&tire on the hub with lug nuts.
- >Tighten the lug nuts with your fingers in the cross sequence patten as shown.
- >Tighten the lug nuts to 50-85 ft.lbs torque.
- >Continue to follow the cross sequence patten until the correct torque is reached.

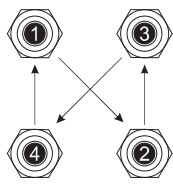
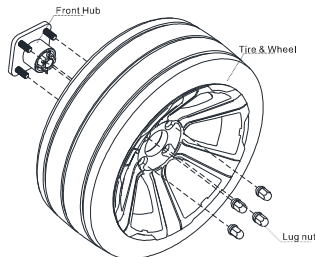

Cross Sequence

LIFT AND LOWER THE VEHICLE

Read carefully all the safety statements before attempting any procedure.

LIFT AND LOWER THE VEHICLE

WARNING

LIFTING AND LOWER THE VEHICLE WITH CARGO CAN CAUSE PROPERTY DAMAGED, SERIOUS PERSONAL INJURY, OR DEATH. REMOVE ALL CARGO AND HAVE THE PERSON OUT FROM THE VEHICLE BEFORE THE VEHICLE IS LIFTED.

Steps For Lifting The Vehicle:

- > Before the vehicle is lifted, turn off key switch of the vehicle.
- > Choose the jacks and jack stands rated for the vehicle.
- > Engage the parking brake.
- > Place the jack in the center of the lift point.
- > Lift the front and rear of the vehicle.
- > Put the Jack stands under the frame rails.
- > Lower the vehicle onto the jack stands.

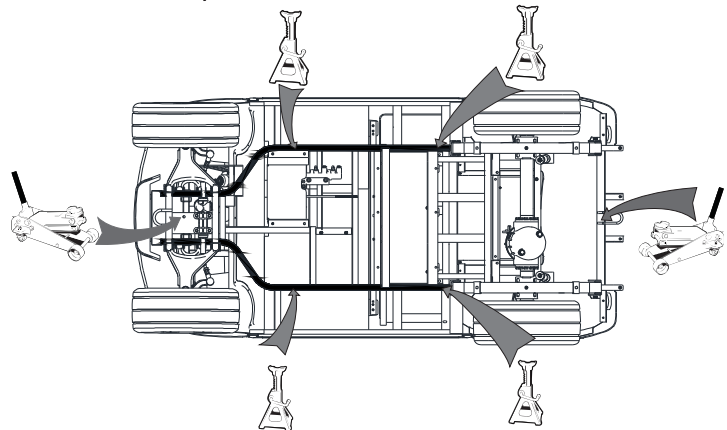

Steps For Lower The Vehicle:

- > Before the vehicle is lowered, turn off key switch of the vehicle.
- > Choose the jacks and jack stands rated for the vehicle.
- > Place the jack in the center of the lift point.
- > Lift the vehicle off from the jack stands.
- > Remove the Jack stands under the frame rails.
- > Lower the vehicle on the ground.
- > Remove the Jacks.



VEHICLE MAINTENANCE

Read carefully all the safety statements before attempting any procedure.

VEHICLE MAINTENANCE

WARNING

WARNING UNINTENDED VEHICLE OPERATION CAN CAUSE SERIOUS PERSONAL INJURY OR DEATH. BEFORE LEAVING THE VEHICLE OR DURING VEHICLE MAINTENANCE, DISABLE THE VEHICLE. ONLY TRAINED TECHNICIANS SHOULD SERVICE OR REPAIR THE VEHICLE. ANYONE DOING EVEN SIMPLE REPAIRS OR SERVICE SHOULD HAVE KNOWLEDGE AND EXPERIENCE IN ELECTRICAL AND MECHANICAL REPAIR. THE APPROPRIATE INSTRUCTIONS MUST BE USED WHEN PERFORMING MAINTENANCE, SERVICE, OR ACCESSORY INSTALLATION.

FAILURE TO CORRECTLY MAINTAIN THE VEHICLE AND MAKE NECESSARY REPAIRS CAN DECREASE VEHICLE PERFORMANCE, CAUSE A FIRE, PROPERTY DAMAGE, SERIOUS PERSONAL INJURY, OR DEATH. IF PROBLEMS ARE FOUND DURING SCHEDULED INSPECTION OR SERVICE, OPERATE THE VEHICLE ONLY WHEN REPAIRS ARE MADE.

DO NOT WORK ON THE VEHICLE POWERTRAIN WHEN THE VEHICLE IS LOADED.

DO NOT WEAR LOOSE CLOTHING OR JEWELRY SUCH AS RINGS, WATCHES, CHAINS, ETC., WHEN SERVICING THE VEHICLE OR BATTERY CHARGER.

LIFT ONLY ONE END OF THE VEHICLE AT A TIME. USE A SUITABLE LIFTING DEVICE WITH 1000 LB (454 KG) MINIMUM LIFTING CAPACITY. DO NOT USE THE LIFTING DEVICE TO HOLD THE VEHICLE IN THE LIFTED POSITION. USE APPROVED JACK STANDS OF PROPER WEIGHT CAPACITY TO SUPPORT THE VEHICLE AND CHOCK THE WHEELS THAT REMAIN ON THE FLOOR. IF WIRES ARE REMOVED OR REPLACED, MAKE SURE THAT THE WIRING AND WIRE HARNESS ARE CORRECTLY ROUTED AND ATTACHED. FAILURE TO CORRECTLY ROUTE AND ATTACH THE WIRING COULD RESULT IN VEHICLE MALFUNCTION, PROPERTY DAMAGE, SERIOUS PERSONAL INJURY, OR DEATH.

CAUTION

WEAR SAFETY GLASSES OR APPROVED EYE PROTECTION WHEN YOU DO THE SERVICING OF THE VEHICLE. WEAR RUBBER GLOVES WHEN NEAR THE BATTERY.

VEHICLE MAINTENANCE

Read carefully all the safety statements before attempting any procedure.

VEHICLE SCHEDULED MAINTENANCE CHART

Regular maintenance is required for the best performance and safe operation of the electric vehicle . Periodic maintenance need to perform accordingly .

Item	Descriptions	1D-per day	1W-per week	1M-per month	1Q-per quarter	1Y-per year
Battery	1.Check the liquid level .Add distilled water in necessary . (Lead-acid battery only)		v			
	2.Charge the battery .		v			
	3.Tighten the nut on the battery cable .		v			
	4. Fasten the nut of the battery electrode .			v		
	5.Check whether the battery is over-charged .			v		
	6.Check the liquid density of the battery .			v		
	7.Check whether the battery is fully charged .			v		
	8.Clean the surface of battery .			v		
Charger	9.Observe the charging status, check if the charger plug becomes hot.		v			
	10.Clean the surface of charger . Do not let water enter into charger .			v		
Motor and controller	11.Check whether all terminals are tightened properly(Turn off the power).			v		
	12.Clean the surface of the controller.				v	
	13.Check whether the solenoid is in order, checking the touching point.					v
	14.Check whether there is water get into motor.		v			
	15.Check whether all the connectors of motor & controller are tightened			v		
	16. Check whether the accelerator pedal works well .		v			
Chassis and body	17.Check whether the brake pedal is firm and can be released freely .			v		
	18.Check whether the brake drum and brake shoe need to be replaced or not				v	
	19.Check the hand break function.			v		
	20.Check the break liquid tank liquid level .			v		
	21.Check tire pressure and tire surface .		v			
	22.Check Whether the shock is leaking or not .			v		
	23.Fasten the bolt of shaft .			v		
	24.Check whether there is sufficient oil inside of rear axle gear box .				v	
	25.Add grease to front hub and steering gear box .				v	
	26. Adjust the front and rear suspension .				v	
	27.Clean the body and seat .	v				

NOTICE

The Maintenance Service Schedule must be done more frequently on vehicles that are constantly subjected to heavy use or severe operating conditions.



VEHICLE MAINTENANCE

Read carefully all the safety statements before attempting any procedure.

CHASSIS MAINTENANCE

Check the dust-proof cover on steering gear box, the covers are supposed to be tightened on the two terminal ends .
Loose cover will let water and dust into the gear box , cause the gears rusting .

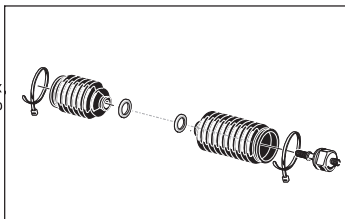

Add lubricant to mechanical joint parts , the vehicle should be kept in good turning and operating functions . To acquire that one should add lubricant to needed parts every one month .

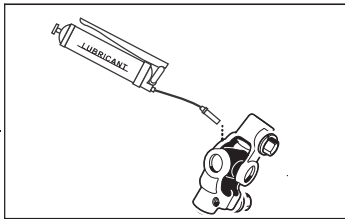

Check the tires every time use the vehicle, the tires should be inflated with enough air. The air pressure should with normal level. Check the tire chapter for more specific information of tire inflation .

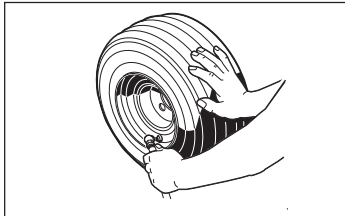

⚠ DANGER
FLAT TIRE MAY CAUSE UNSTABLE STEERING FUNCTION WHILE DRIVING .

Check the tires every time use the vehicle , remove embedded objects or metal items away from tire surface. If the tire have embedded objects on surface , it will lead to excessive noises from tire while driving or tire internal air leaking .

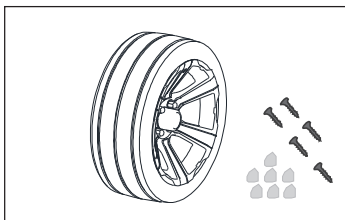

VEHICLE MAINTENANCE

Read carefully all the safety statements before attempting any procedure.

CHASSIS MAINTENANCE

Check the lubricant capacity of rear axle.

⚠ CAUTION

Low lubricant capacity may cause damages to rear axle cams or excessive noises .

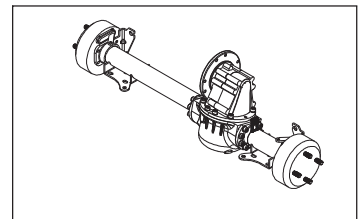

Clear the brake shoes surface , all the brake shoes shred dust should be cleaned out in periodic time. Shred dust may cause mechanical malfunctions of brake. Use a compressed air to blow the dust out.

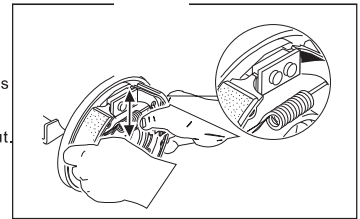

Check the brake shoes worn out conditions , if it is extremely worn out (1/3 left) , then the brake shoes need to be replaced with a new one.

⚠ DANGER

DO NOT DRIVE THE VEHICLE WITH POOR BRAKE

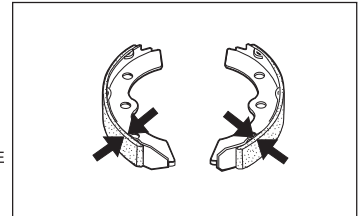

Check the bearings inside of front hub , the hubs should have enough lubricating grease .

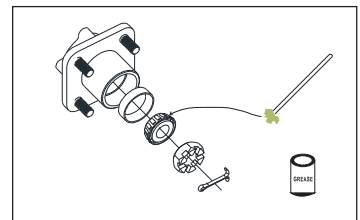

VEHICLE MAINTENANCE

Read carefully all the safety statements before attempting any procedure.

ELECTRIC COMPONENTS MAINTENANCE

Check the headlight back rubber caps , the caps should always be kept on tightly. Otherwise water or dust may enter into the headlight chambers. Cause halogen bulbs burn down easily and vague vision of headlights .



Keep LED rear lights waterproof , keep the cover lid tight ,keep dust and water out of LED light assembly.Dense humidity or water may cause LED diodes burnt down .



CAUTION
DO NOT LOAD LED LIGHTS WITH HIGH VOLTAGES .

Keep the controller from water , water may cause circuitry short. If water enter into controller, the vehicle may not run unintentionally after turn on the power switch.

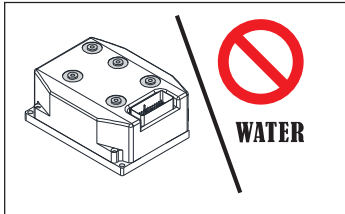

Check fluid level before and after charging, electrolyte should be at least 1/2" (13mm) above the plates and 1/4" tp3/8" (6 to 10mm) below bottom of the vent .

DANGER
NEVER CHARGE BATTERY WITH LITTLE ELECTROLYTE , IT MAY CAUSE OVERHEATED OR EVEN EXPLOSION

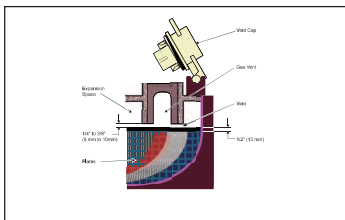

VEHICLE MAINTENANCE

Read carefully all the safety statements before attempting any procedure.

ELECTRIC COMPONENTS MAINTENANCE

Use a hydrometer to check the specific gravity of the battery fluid in each cell .Fluid density ranges from different values in different period of battery using.
Maintenance period :One time per 1 months

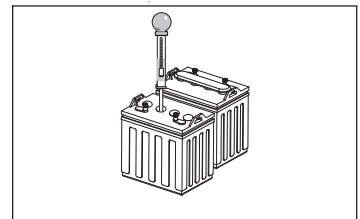

Use a injection faucet to inject distilled water into the battery when the battery does not have enough capacity of battery fluid .

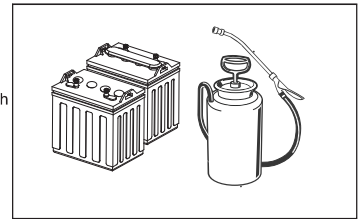

CAUTION

- >Always remember to take precautions while conducting any operations on batteries.
- >Wear gloves to protect person from acid corrosion. Wear glass to protect person from acid splash.
- >Use proper lifting techniques when moving them. Always lift the battery with a commercially available battery lifting device.
- >Wrap wrenches with electric tape to prevent the possibility of a dropped wrench from 'shorting out' a battery, which could result in an explosion and severe personal injury or death

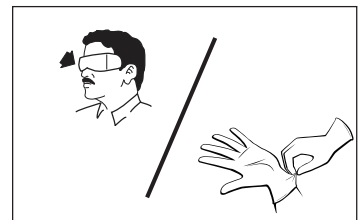
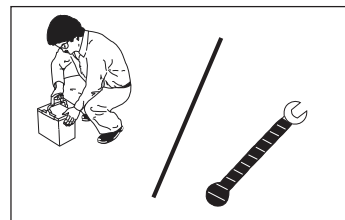

VEHICLE MAINTENANCE

Read carefully all the safety statements before attempting any procedure.

VEHICLE CLEANING AND CARE

⚠ WARNING

MOISTURE CAN CAUSE ELECTRICAL COMPONENT DAMAGE. DO NOT USE A PRESSURE WASHER OR STEAM CLEANER TO CLEAN THE VEHICLE ELECTRICAL SYSTEM. OTHERWISE IT WILL CAUSE ELECTRICAL FAILURE PERMANENTLY.

Pre-operation before cleaning the vehicle:

1. Move the vehicle on a solid flat ground.
2. Apply the parking brake.
3. Turn the key switch to OFF
4. Remove the key.
5. Place the DNR switch to N.

- Use only commercially available automotive cleaners with a sponge or soft cloth for normal cleaning. A garden hose at normal residential water pressure is sufficient.
- Use a commercially available aluminum cleaner paste and fine grade (No. 00) steel wool to remove oxidation or discoloration from aluminum.
- Use non-abrasive wax products. Fertilizers, asphalt, creosote, paint, or chewing gum should be removed immediately to prevent possible stains.
- The seats of the vehicle will last longer with proper cleaning. Use a solution of 10% liquid soap and warm water applied with a soft cloth. Use a soft bristle brush to remove embedded dirt.
- Use mild soapy water and a micro-fiber cloth to clean the windshield to minimize the risk of scratching. Avoid using glass cleaners or paper towels as these increase the chances of scratching or scuffing the windshield.

VEHICLE MAINTENANCE

Read carefully all the safety statements before attempting any procedure.

VEHICLE STORAGE

⚠ WARNING

INCORRECT STORAGE CAN CAUSE BATTERY DAMAGE, PERMANENT LOSS OF BATTERY CAPACITY, OR CAUSE THE BATTERY TO BE UNSERVICEABLE. A FULLY DISCHARGED BATTERY PUT IN STORAGE WILL MAKE THE BATTERY PERMANENTLY UNSERVICEABLE. PUT THE BATTERY ON CHARGE DURING EXTENDED STORAGE. DO NOT EXCEED THE STORAGE TEMPERATURE LIMITS. DO NOT PUT A FULLY DISCHARGED BATTERY IN STORAGE. INCORRECT STORAGE WILL VOID THE BATTERY WARRANTY.

PREPARATION BEFORE STORING THE VEHICLE

A HDK ELECTRIC VEHICLE gives you years of trouble-free service when properly maintained. Please follow the recommended long-term storage checklist. For more information on overall vehicle maintenance, consult the owner's manual.

TWO WEEKS PRIOR TO THE STORAGE

Perform the following procedure at least two weeks prior to long-term storage to ensure proper mixing of water and electrolyte. It takes approximately five charge cycles with a minimum of 10 EUs removed to properly mix the water with electrolyte. DO NOT water batteries immediately prior to storage. This will not provide sufficient charge time to mix the water with the electrolyte. Freezing can occur when batteries are stored in this condition.

For Lead-acid Battery :

Make sure the vehicle is plugged in and the proper electrolyte level is maintained throughout the entire storage period. Perform the following procedure at least two weeks prior to long-term storage to ensure proper mixing of water and electrolyte. It takes approximately five charge cycles with a minimum of 10 EUs removed to properly mix the water with electrolyte. DO NOT water batteries immediately prior to storage. This will not provide sufficient charge time to mix the water with the electrolyte. Freezing can occur when batteries are stored in this condition.

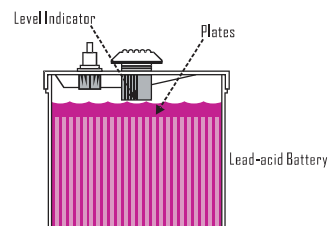

For Lithium Battery :

Make sure the vehicle battery is plugged in for charging throughout the entire storage period.

VEHICLE MAINTENANCE

Read carefully all the safety statements before attempting any procedure.

JOBS TO BE DONE PRIOR TO THE STORAGE

- > Put golf cart under shelter, keep the golf cart in dry and ventilated space. Optimal temperature 14°F to 95°F (-10°C to 35°C). Maximum storage temperature should not be higher than 122°F (50°C).
- > Turn the key switch to the OFF position, remove the key and leave the forward/reverse switch in the NEUTRAL position during storage.
- > Power down all accessories.
- > Clean the battery packs, tops and terminals using a battery acid neutralizer (1 cup baking soda per 1 gallon water). Check, clean and treat battery terminal connections with a battery terminal protector spray.
- > If your vehicle is equipped with a Single Point Watering System (for golf carts with lead-acid battery), place the fill tube on top of the battery. This allows any water in the tube to drain back into the batteries.
- > Disconnect batteries per ensuring that the cables do not come into contact with a terminal (Disconnect the 48V Main power outlet cables from battery pack, insulate the cable).
- > Connect Battery cables back to system, charge the battery to full state every 1-3 months to keep battery alive without damages caused by over-discharging.
- > Perform all semi-Annual Lubrications.
- > Thoroughly clean the front and rear body, seats, battery compartment and underside of the vehicle. > DO NOT engage the park brakes, but secure the golf cart from rolling. Check the wheels with wheel stopper or something similar.
- > Check Tire pressure and inflate the tires to standard pressure level as values presented on tires.
- > Perform all semi-Annual Lubrications.
- > Thoroughly clean the front and rear body, seats, battery compartment and underside of the vehicle.
- > DO NOT engage the park brakes, but secure the golf cart from rolling. Check the wheels with wheel stopper or something similar.

RETURNING THE VEHICLE TO SERVICE FROM STORAGE

1. Fully charge the battery.
2. Set the Forward /Reverse control (DNR) to N.
3. Adjust the pressure in each tire to the recommended tire pressure.
4. Have a trained technician lubricate the vehicle.
5. Do a daily pre-operation safety checklist.
6. Do a vehicle performance inspection.

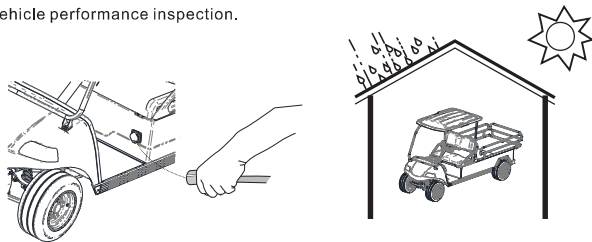

VEHICLE MAINTENANCE

Read carefully all the safety statements before attempting any procedure.

VEHICLE TRANSPORTATION AND TOWING

WARNING

- > DO NOT RIDE ON OR ALLOW OTHER PEOPLE ON A VEHICLE BEING TRANSPORTED ON A TRAILER OR BEING TOWED WITH ANOTHER VEHICLE.
- > DO NOT CARRY PASSENGERS ON GOLF CART WHILE TOWING THE VEHICLE.
- > APPLY BRAKE TO LIMIT SPEED WHEN COMMIT SHARP TURNS.
- > APPLY BRAKE TO LIMIT SPEED WHEN TOW THE GOLF CART ON UNEVEN TERRAIN.
- > TURN ON THE HAZARD LIGHTS IF VEHICLE WAS CONFIGURED WITH.
- > SECURE THE SEATS/WINDSHIELD/OTHER LOOSE ITEMS BEFORE TOWING GOLF CART.
- > DO NOT TOW MULTIPLE GOLF CARTS IN SERIES FORMATION.
- > DO NOT TOW THE GOLF CART ON HIGHWAY ROADS.
- > ABORT TOWING WHEN ABNORMAL PHENOMENONS BEING DETECTED.
- > ABORT TOWING WHEN ABNORMAL PHENOMENONS BEING DETECTED.

The following steps can help you to tow an HDK golf cart safely without any damage.

- Turn off key switch.
- Keep the Forward/Reverse switch in a neutral position.
- If you need to tow the golf cart for long distance, remove the battery connections from battery pack terminals. This is done to ensure that the Rear axle /Motor/Controller/Batteries do not get damaged during the towing process
- Move the golf cart at a slower speed (Optimally Between 5-15MPH) or the same speed that you would generally move it if it has power. Exceeding the speed limit can over-spin the motor and ruin it.
- Pulling your golf cart faster than designed to go can over-spin the motor. Possible slinging the internal parts into pieces and ruining the motor.
- Unlock the parking brakes. If you have a EM brake on your golf cart motor, make sure unlock it mechanically before towing the golf cart.



VEHICLE GENERAL SPECIFICATION

Read carefully all the safety statements before attempting any procedure.

VEHICLE GENERAL SPECIFICATIONS

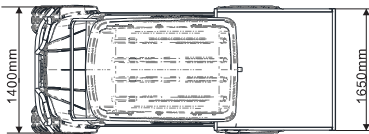
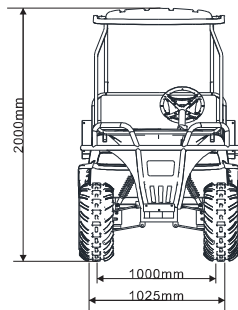
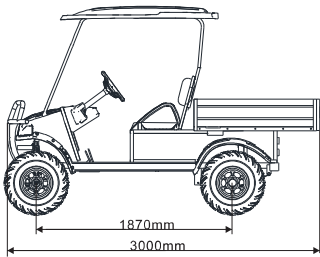
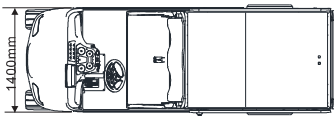
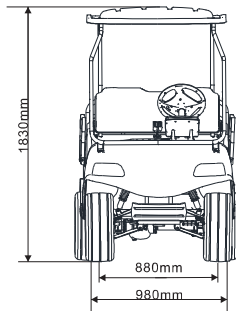
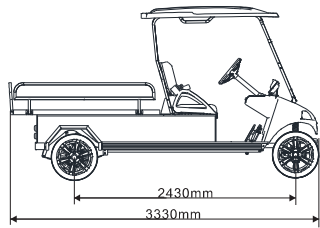

VEHICLE GENERAL SPECIFICATION

Read carefully all the safety statements before attempting any procedure.

VEHICLE GENERAL SPECIFICATIONS

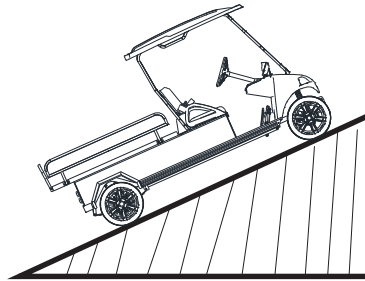

**Recommended Max Ramp
25% Grade**

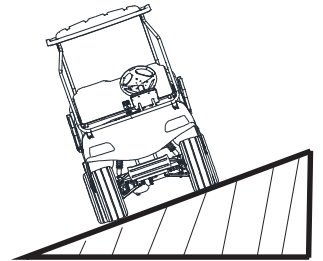

**Recommended Max Side Tilt
25% Grade**

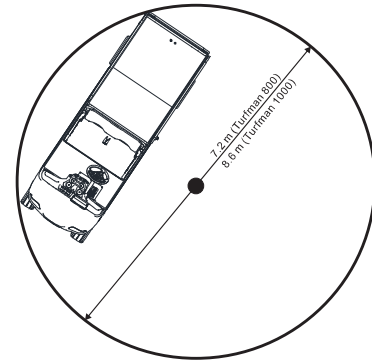

Vehicle Turning Clearance Diameter

